

---

## Watts and CCT Selectable UFO High Bay Pro

---

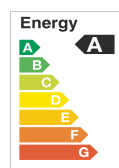

## Features

1. Simple and stylish appearance.
2. Excellent heat dissipation.
3. DLC 5.1 Premium with high luminous efficacy and low UGR.
4. Branded driver and LED's.0-10V dimming
5. PnP sensor option.
6. Mounting options: hook/chain, pole pendent and surface mounting.
7. Round EM driver for fast installation.
8. Very complete accessories for option.
9. CCT(3500K-4000K-5000K).

## Product Dimension

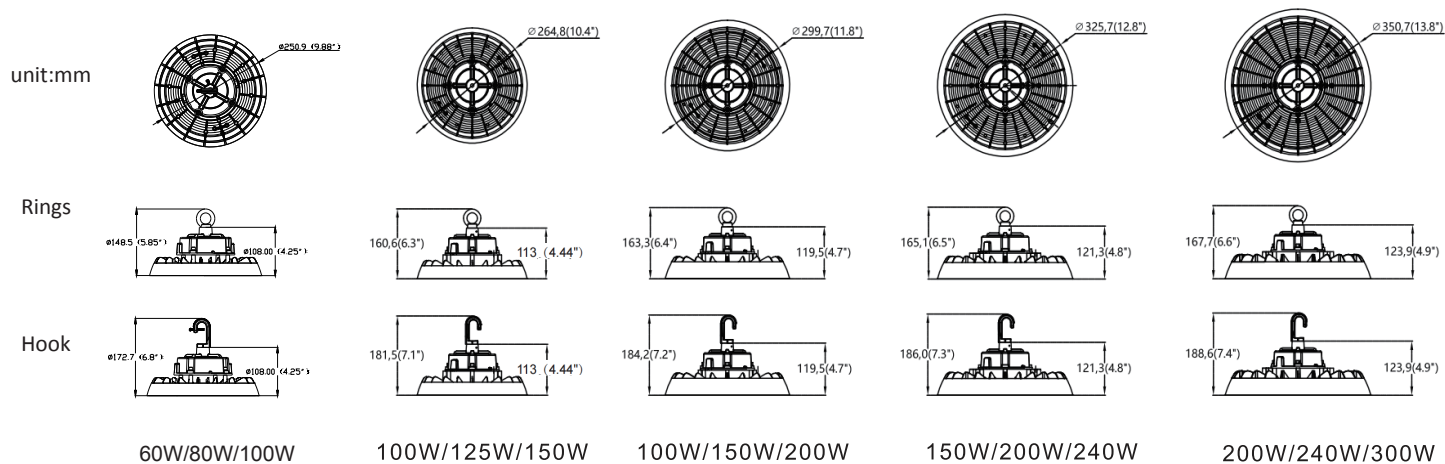

## Lighting Parameters

Model Number	Wattage	Working Voltage	CCT	Lamp Bead Model	LED Driver	Beam Angle	Lighting Efficiency	Color Rendering Index	Operating Temperature	Storage Temperature	Environment Location	Life span	Lamp shell
UHB1210-100W-110-H-TCP	60W/80W/100W	AC 120-277V or 120-347V	3500K 4000K 5000K	2835	Lifud	110°	140LMW & 150LMW	Ra>80	-40°F~122°F -40°C~50°C	-40°F~158°F -40°C~70°C	Wet Location	≥50000H	Black & White
UHB1210-150W-110-H-TCP	100W/125W/150W												
UHB1215-200W-110-H-TCP	100W/150W/200W												
UHB1220-240W-110-H-TCP	150W/200W/240W												
UHB1230-300W-110-H-TCP	200W/240W/300W												

"XXX" can be any letter or number to represent light-emitting angle;

"X" can be H, L or HY (Y=number) to represent lighting effect (no effect to power);

"XXX" can be XXK,TCP, TP-XXK or TC. "XXK" can be "35K", "40K", "50K", "57K", "65K"

TCP=Adjustable power and CCT, TP-XXK =Single CCT with adjusting power, XXK can be any number, for example 30K=3000K, TC=Adjustable CCT;

"(XX)" can be (MS),(PIR),(BT) to indicate Microwave Sensor, PIR Motion sensor, Motion Sensor with Bluetooth or blank to indicate without Motion Sensor.

Last "XXX" can be blank or any letter or number or combination of letters and numbers to represent commercial code.

## CCT and Watts selected Operation Manual

1.Remove the rubber pad from the driver

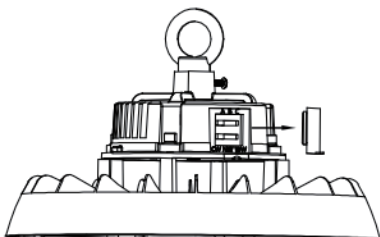

2.Use the slide switch to select wattage and CCT

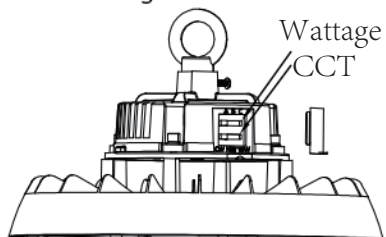

3.Attach the rubber pad to the driver

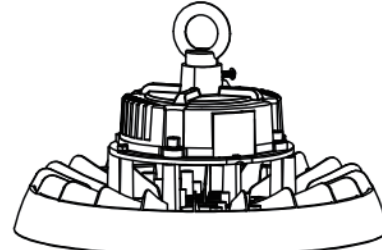

## Installation Instruction

### 1. Rings type:

1.Tighten the ring clockwise

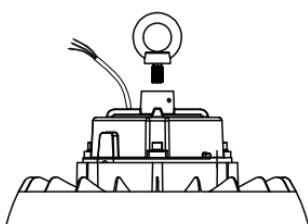

2.Tighten the screw

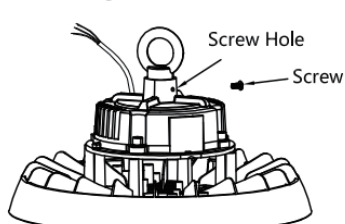

3.Hang the light

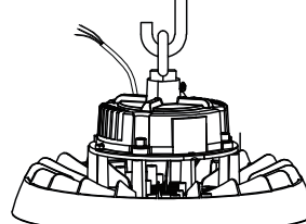

### 2. Hook type:

1.Tighten the hook clockwise

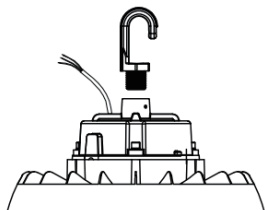

2.Tighten the screw

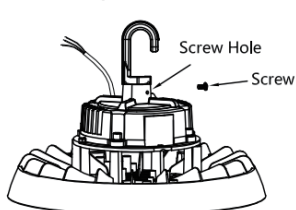

3.Hang the light

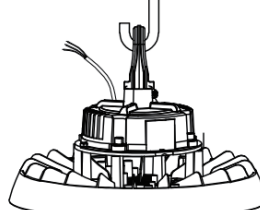

4.Tighten the screw

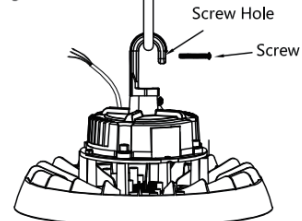

## Packing information

Power	Outer box (L*W*H)	Oty/Ctn (pcs)	N.W./Ctn (kg/lbs)	G.W./Ctn (kg/lbs)	Remarks
100W	11.73"x11.73"x6.5"(298*298*165mm)	1	1.40/3.09	2.22/4.85	2M cable
150W	12.01"x12.01"x6.89" (305*305*175mm)	1	1.75/3.56	2.75/6.06	
200W	14.49"x14.49"x6.97" (368*368*177mm)	1	2.10/4.63	3.25/7.17	
240W	15.43"x15.43"x7.09" (392*392*180mm)	1	2.50/5.51	3.72/8.20	
300W	16.46"x16.46"x7.17" (418*418*182mm)	1	2.80/6.17	4.05/8.93	

## Applications



Industrial application:  
Warehouse, Factory etc.

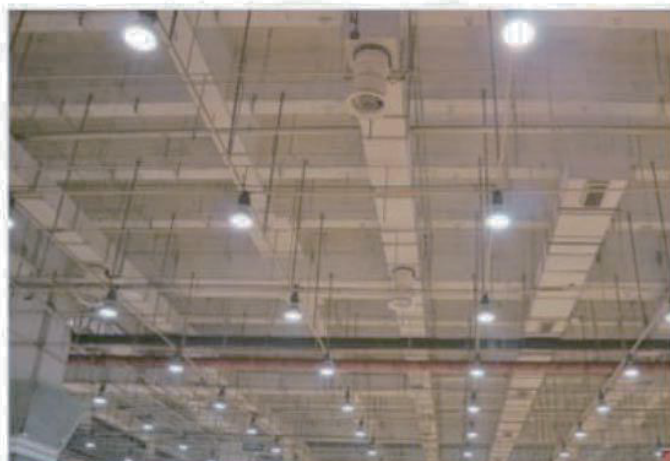

Commercial application:  
Exhibition Room, Gas Station,  
Supermarket etc.

## Note

1. Any form of installation/uninstallation or maintenance and electrical work must only be performed by a qualified electrician.
2. All wiring should be done after cutting off the power.
3. The UFO high bay light must be grounded.
4. Always keep the lens/diffuser of UFO high bay light cleaned to maintain good light transmission.
5. Always keep the shell of UFO high bay cleaned to maintain good heat dissipation.
6. Cleaning must only be done with dry or wet cloth and the high bay should not be exposed to corrosive substance.
7. High voltage inside the fixture, please do not disassemble it, Serious electric shock may occur otherwise.